

1

2

3

4

NOTES:

- (1) PURGE ALL WATER SUPPLY LINES TO REMOVE SOLIDS PRIOR TO TOY INSTALLATION.
- (2) PROVIDE ELECTRICAL BOND WITH POOL REBAR.
- (3) INSTALL ALL WATER TOYS PLUMB AND LEVEL.
- (4) PROVIDE STRAINER UPSTREAM OF TOY WITH MAX 1/32" (0.8mm) PERFORATIONS.

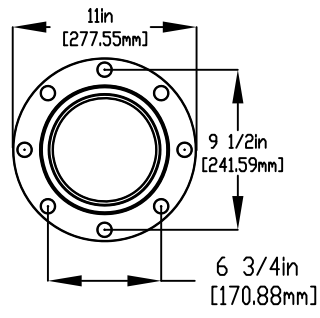
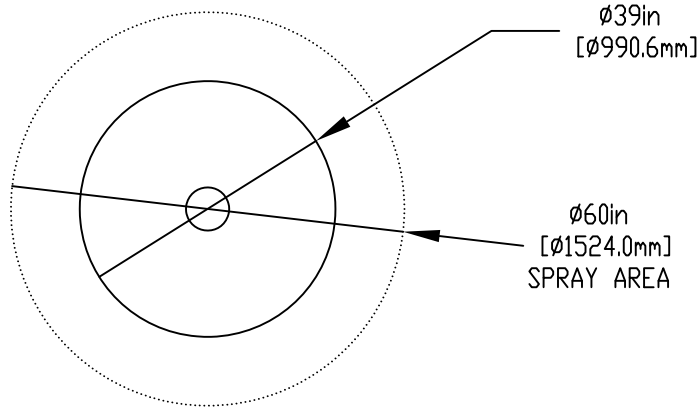

FLANGE DETAIL

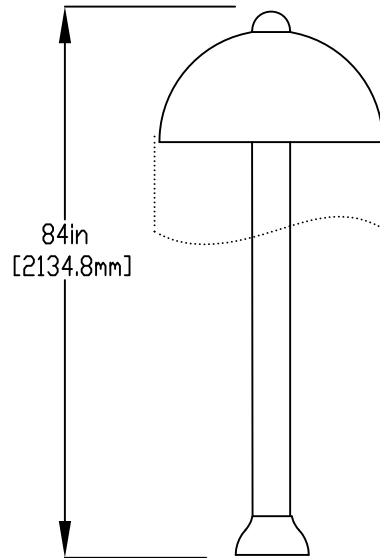

LOWER FLANGE COVER AFTER TOY IS INSTALLED.

5/8" (16mm) X 9" (229mm) 316SS
 THREADED ROD C/W FENDER WASHER,
 LOCK WASHER & NUT (X6). MINIMUM
 6" (152mm) EMBEDMENT, EPOXY SET
 ANCHOR ADHESIVE
 TO BE PROVIDED BY CONTRACTOR

ENSURE LEVEL & PLUMB
 6" (152mm) X 1/8" (3mm) GASKET
 INSTALLED UNDER FLANGE.
 PROVIDED BY EMPEX

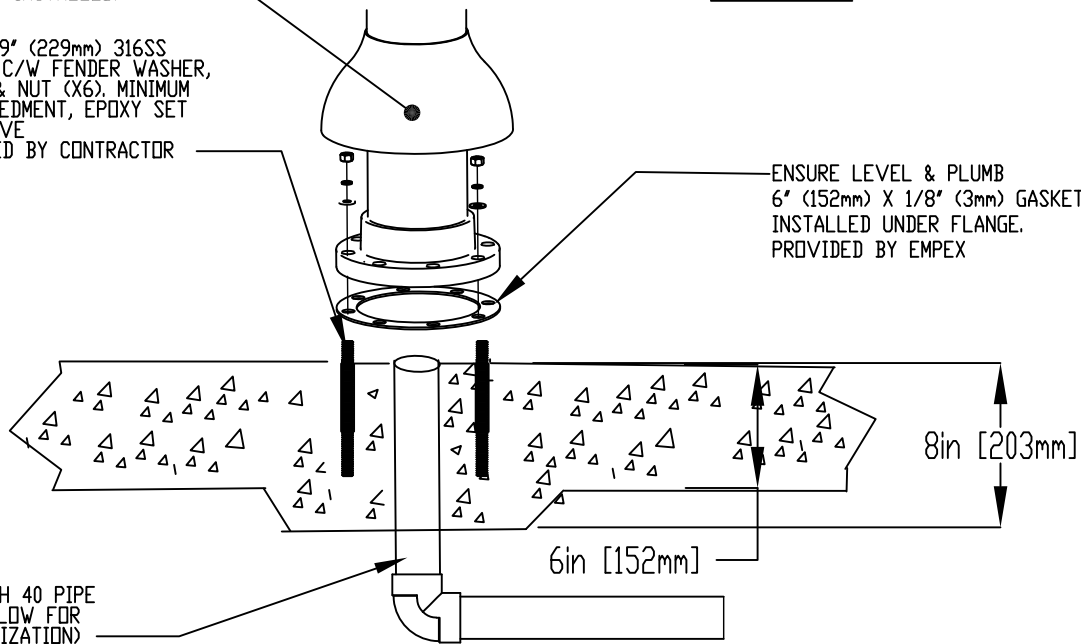

WATERFEED
 2" (50mm) PVC SCH 40 PIPE
 CUT CLOSE TO ALLOW FOR
 DRAINAGE (WINTERIZATION)

Notes: Overall dimensions of toys are approximate.
 Approximate Weight: 80lbs (36.4kgs)

© EMPEX WATERTOYS



WATER SUPPLY
 40 gpm @ 25 psi
 2.5 L/S @ 17.5m

AQUABRELLO MINI LARGE

T887L

28/08/2023

SCALE:

Sheet 1 of 1

1

2

3

4